



Litemeter Pro configuration

Best Practice Installation Manual

Issue 01
Date 11-01-2023

Index

1.Recommended to do during the installation.....	3
1.1 Mechanical.....	3
1.2 Electrical.....	4
1.3 Configuration software/Firmware.....	5
2. Not recommended to do during the installation.....	7
3. MODBUS troubleshooting.....	8
4.Contact and Customer support.....	11

About This Document

Purpose

This document introduces the best installation practices for the configuration set up of Soluzione Solare sensor – Litemeter 485 PRO by briefly mentioning the recommended and not recommended practices during the field installation. This document also gives clear instructions related to troubleshooting of MODBUS 485 configurations.



Intended Audience

This document is intended for consumers of Soluzione Solare sensors and qualified electricians.

1. Recommended to do during the installation

1.1 Mechanical

- (1) The Litemeter Pro 485 usually comes with a loose pin ends. User can specifically request if they require a Litemeter Pro 485 manufactured with a male connector end.
- (2) In order to get the right fit of male and female side of the connector pin, turn the male side of the connector less than 360° for finding the right position.



- (3) After finding the right position, tighten the connection only by rotating the steel ring and make sure you do not rotate the connector.
- (4) Always clamp the Litemeter Pro sensor on parallel side of the PV module in order to avoid casting of the shadow on the PV module behind it.
- (5) Make sure the sensor is placed on the same plane and angle as of the PV module array for optimal measurements.



1.2 Electrical

- (1) For proper cable connections, please refer to the instruction manual that comes along with the Litemeter Pro device and also you can find it in this following link:

https://soluzionesolare.com/wp-content/uploads/2022/12/Manu_LM5-485-PRO_22.pdf

Conn.pin		
#	Cable colour	Description
1	Green	RS485+/B, communication bus non inverting signal
2	Red	Power supply +9 ÷ 30Vdc
3	Green/White	RS485-/A, communication bus inverting bus signal
4	Black	Power supply / Signal 0 Vdc
5	Black with Blue Tip	Gnd

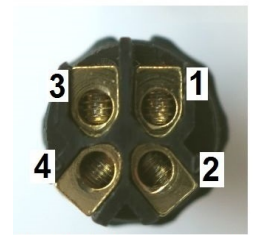

- (2) Power supply should be connected with the exact pins as the manual indicates and the suitable voltage to be supplied is 9-30 Vdc.
- (3) For the connections, we suggest you to use twisted cables which are shielded.
- (4) Always connect the shield to the ground.
- (5) If there is no signal received from the RS485 port, try to swap the cables A and B and check again if the signal is received.

1.3 Configuration software/Firmware

- (1) For the first time after unboxing the Litemeter Pro, connect it using the default settings (Address = 60,Baud rate =19200 and Serial configuration = 8N1).

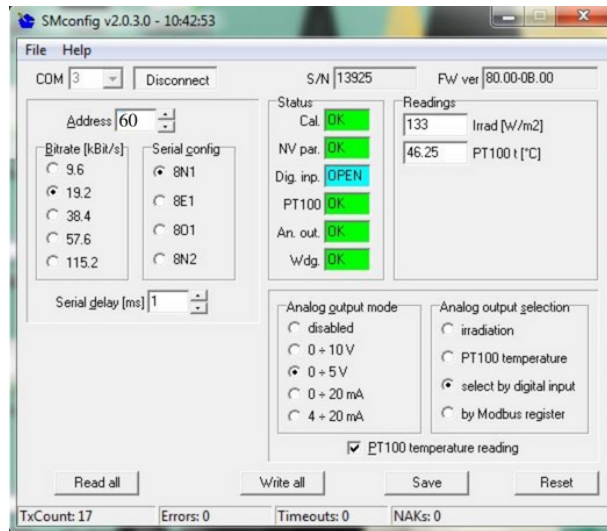

- (2) After turning on the Litemeter Pro, please wait for 5 seconds before connecting it to the SM config software in order to achieve a proper configuration.
- (3) In case, if you need to change the default settings value, use the SM config software by first connecting the device with the default setting values mentioned in point 1 and then change them to the required values.
- (4) After changing the values click these buttons in the sequence as mentioned 1)Read all 2)Write all 3)Save and 4)Reset

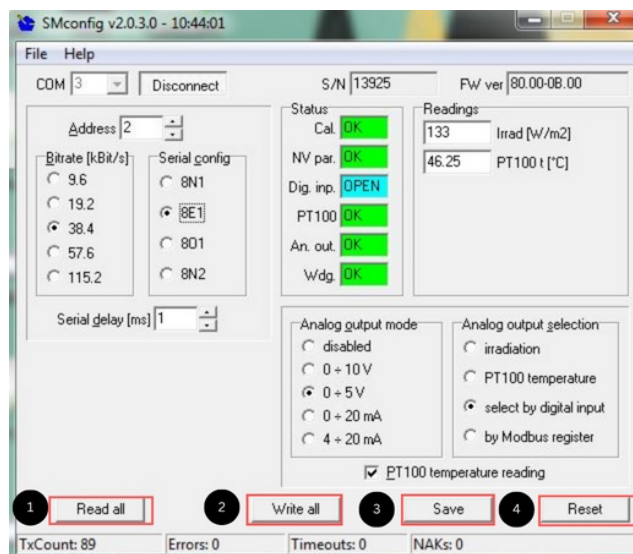

- (5) Please ensure you leave a time gap of 2 seconds in between clicking each buttons.
- (6) We recommend you to place a label on the Litemeter Pro with the new settings in order to remember the modified new settings.
- (7) Bit rate should be set low in case of long wire connections and environment with more electrical noises.

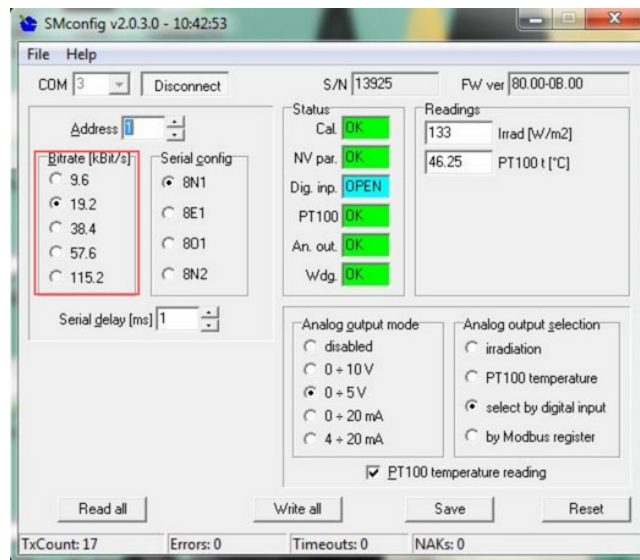

2. Not recommended to do during the installation

1. It is not recommended to connect the Litemeter Pro at the bottom side of the PV module, since there will be casting of shadows on the sensor which could modify the readings and also sensor could get affected in case of rain water flow. Always clamp the sensor on the parallel side of the PV module in order to avoid casting of shadow on the PV module behind it. Alternately in rare cases, Litemeter Pro sensor can be clamped on top of the PV module when there is an optimal distance between the two rows of the PV modules.



2. Do not supply voltage which is very low or very high from the recommended values mentioned in the user manual.

<i>Supply</i>	<i>Ext. Current loop</i>	<i>9 ÷ 30 Vdc protected against reverse polarity, short circ.</i>
---------------	--------------------------	---

3. Do not let the PINs get exposed to water and humidity. It is recommended to use a sealed box to place the wires in order to protect it from water and humidity.
4. Do not bend the connectors or cables and it is not recommended to place it on sharp edges.
5. It is not recommended to use dusty sensors which could show a deviated readings. Always clean the sensors for optimal readings.

3.MODBUS troubleshooting

Important Note !!

In General, Dataloggers and Soluzione Solare sensor devices comes with lines which are polarized by default. **Only incase** if you face any problem with the MODBUS communication please refer to the steps given below.

(3.1) For troubleshooting and information about MODBUS protocol kindly visit <https://modbus.org/> even for recommendations on polarization. Kindly check the general schema of the MODBUS RS485 protocol given below.

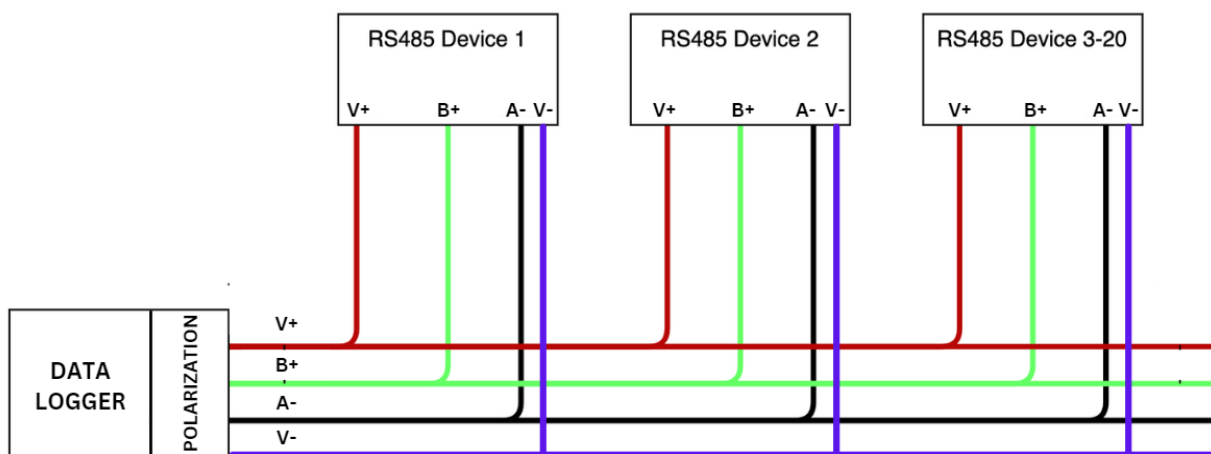

(3.2) In case if you have a bad communication and in order to have a right polarization, follow this formula for calculating the voltages between B+ and A- for finding out if the connections satisfy the condition

$$V_{B+} - V_{A-} \geq 0.2 \text{ V}$$

Polarization network

If the above condition is not satisfied, please refer to the polarization network to be inserted on the bus

$$\text{B+ potential value: } V_{B^+} = \frac{(R_2 + R_3)V^+}{(R_1 + R_2 + R_3)}$$

$$\text{A- potential value: } V_{A^-} = \frac{(R_3)V^+}{(R_1 + R_2 + R_3)}$$

Where R_1 , R_2 and R_3 are the three resistors.(refer to the example images)

V^+ is the supply voltage

If the Datalogger does not have this RS485 polarization net, the user has to do the proxy from input/output.

If the lines are longer user could implement the polarization and if the line is more longer it is suggested to provide with a local power supply which should be polarized.

Examples of local power supply for less than 5 devices connected is given below.

Example for 12V

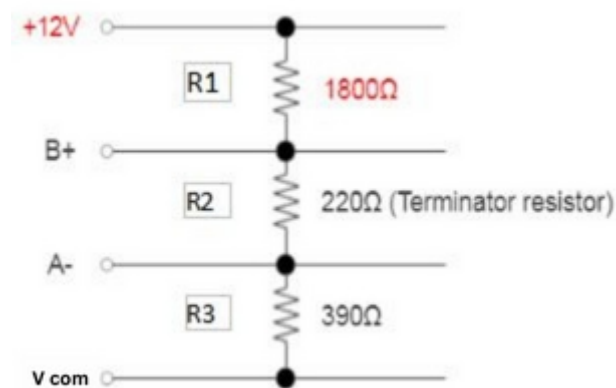

Example for 24V

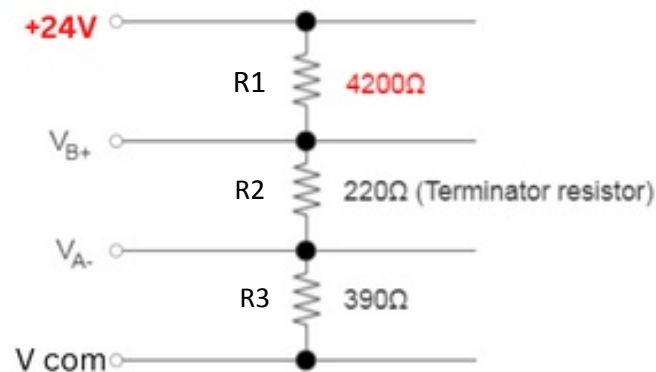

Note

Terminator resistor is required for **high speed and longer lines**, except in the use of dataloggers like Huawei, Sungrow, Goodwe.. etc which **does not** require the terminator resistor even in those above mentioned conditions.

- (3.3) If you have troubles with MODBUS connection which can happen if you have more than a couple of devices from different manufacturers connected in the same RS485 line, it is suggested to test the values along the RS485 cable. If you find it difficult to test the values along the line, MODBUS test box can be used. Please check the output voltage levels and impedance of each terminal using the MODBUS test box.

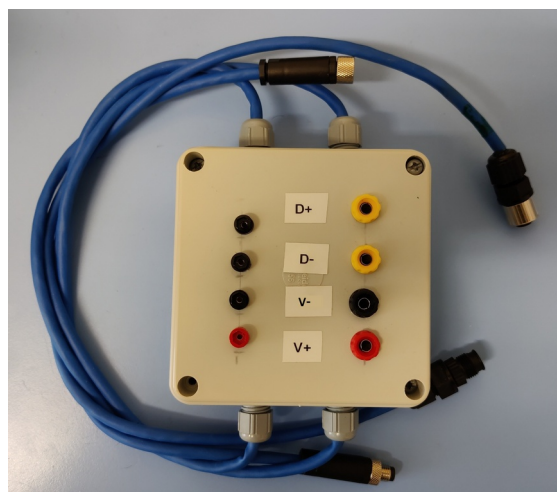

Contact and Customer support

Soluzione Solare S.r.l.

Email: tecnico@soluzionesolare.it

Phone: +39 0444 530234



In case of technical support,

In the email please include the below mentioned information:

- Mention the Device model
- Mention the Device serial number
- Mention the information about the fault or problem
- Attach some pictures which represents the fault or problem